

Sensor/actuator box header - SACB-6/12-L-C GG SCO - 1516755

Please be informed that the data shown in this PDF Document is generated from our Online Catalog. Please find the complete data in the user's documentation. Our General Terms of Use for Downloads are valid (<http://phoenixcontact.com/download>)



Sensor/actuator box header, application: Standard, connection method: M12-SPEEDCON-socket Metal, number of slots: 6, number of positions: 5, coding: A - standard, slot assignment: Double, status display: yes, pnp; master cable connection: Pluggable screw connection, shielding: no



Key Commercial Data

Packing unit	1 pc
GTIN	 4 017918 967482
GTIN	4017918967482
Weight per Piece (excluding packing)	251.100 g
Custom tariff number	85366990
Country of origin	Germany

Technical data

General

Rated voltage	24 V DC
Max. operating voltage U_{max}	30 V DC
Current carrying capacity per I/O signal	2 A
Current carrying capacity per slot	4 A
Total rated current	10 A
	2x 8 A (For electrical isolation)
Number of positions	5
Number of slots	6
Flammability rating according to UL 94	V0
Sensor/actuator connection system	M12-SPEEDCON-socket

Sensor/actuator box header - SACB-6/12-L-C GG SCO - 1516755

Technical data

General

Note	NOTE: Observe the permissible bending radii when laying conductors, since the degree of protection may be put in jeopardy if the bending forces are too high. Alleviate mechanical loads upstream of the connector, e.g. by using cable ties.
	Unused slots are to be sealed off prior to commissioning. Suitable sealing elements are to be found under "Accessories".

Ambient conditions

Degree of protection	IP65
	IP67
	IP69K
Ambient temperature (operation)	-30 °C ... 80 °C

Local diagnostics function

Local diagnostics	Supply voltage per module Green LED
	Status display I/O Yellow LED

Master cable data/connection data

Connection method	Pluggable screw connection
Tightening torque slot sensor/actuator cable	0.4 Nm
Tightening torque of mounting screw for fixing the housing	0.5 Nm

Insulation material

Housing material	PBT
Material of the moulding mass	PUR
Contact material	Cu alloy
Contact surface material	gold-plated
Contact carrier material	PA
Material of contact, master cable side	CU alloy
Material of contact surface, master cable side	gold-plated
Material of the contact carrier on the master cable side	PA 6.6 V0
Material of threaded sleeve	Zinc die-cast
Material of threaded sleeve surface	Nickel-plated
O-ring material	NBR

Pin assignment

Slot/position = Wire color or connection	1 / 4 (A) = 1 / 4
	1 / 2 (B) = 1 / 2
	2 / 4 (A) = 2 / 4
	2 / 2 (B) = 2 / 2
	3 / 4 (A) = 3 / 4

Sensor/actuator box header - SACB-6/12-L-C GG SCO - 1516755

Technical data

Pin assignment

	3 / 2 (B) = 3 / 2
	4 / 4 (A) = 4 / 4
	4 / 2 (B) = 4 / 2
	5 / 4 (A) = 5 / 4
	5 / 2 (B) = 5 / 2
	6 / 4 (A) = 6 / 4
	6 / 2 (B) = 6 / 2
	1-6 / 1 (+ 24 V) = U _N
	1-6 / 3 (0 V) = 0 V
	1-6 / 5 (PE) = PE

Standards and Regulations

Standards/specifications	M12 connector IEC 61076-2-101
Connection in acc. with standard	CUL
Flammability rating according to UL 94	V0

Environmental Product Compliance

China RoHS	Environmentally Friendly Use Period = 50 years
	For details about hazardous substances go to tab "Downloads", Category "Manufacturer's declaration"

Drawings

Schematic diagram

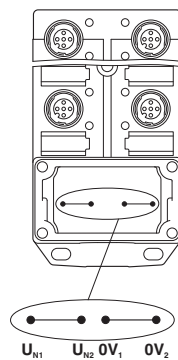

Potential U_{N1} and U_{N2} bridged. Potential assignment: U_{N1} = U_{N2} = slots 1,2,3,4,5,6.

Schematic diagram

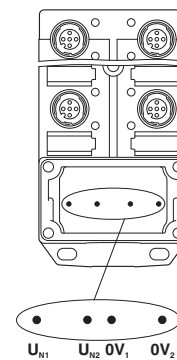

Electrically isolated. Potential assignment: U_{N1} = slots 1,3,5 and U_{N2} = slots 2,4,6.

Sensor/actuator box header - SACB-6/12-L-C GG SCO - 1516755

Dimensional drawing

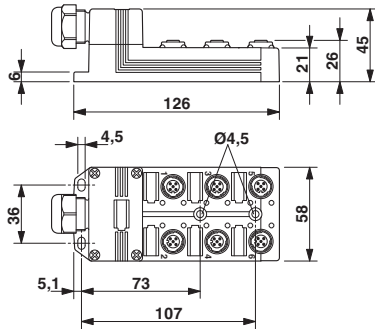

Circuit diagram

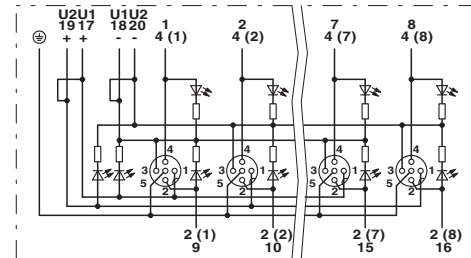

Schematic diagram

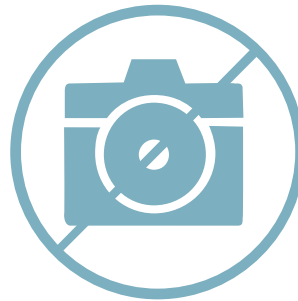

M12 slot, socket, 5-pos.

Classifications

eCl@ss

eCl@ss 10.0.1	27440111
eCl@ss 11.0	27440111
eCl@ss 4.0	27140800
eCl@ss 4.1	27140800
eCl@ss 5.0	27143400
eCl@ss 5.1	27250300
eCl@ss 6.0	27279200
eCl@ss 7.0	27279219
eCl@ss 9.0	27440108

ETIM

ETIM 2.0	EC000200
ETIM 3.0	EC001856
ETIM 4.0	EC002585

Sensor/actuator box header - SACB-6/12-L-C GG SCO - 1516755

Classifications

ETIM

ETIM 6.0	EC002585
ETIM 7.0	EC002585

UNSPSC

UNSPSC 6.01	31261501
UNSPSC 7.0901	31261501
UNSPSC 11	31261501
UNSPSC 12.01	31261501
UNSPSC 13.2	31251501
UNSPSC 19.0	31251501
UNSPSC 20.0	31251501
UNSPSC 21.0	31251501

Approvals

Approvals

Approvals

UL Recognized / cUL Recognized / EAC / EAC / cULus Recognized

Ex Approvals

Approval details

UL Recognized		http://database.ul.com/cgi-bin/XYV/template/LISEXT/1FRAME/index.htm	FILE E 118976
Nominal voltage UN	24 V		
Nominal current IN	3 A		

cUL Recognized		http://database.ul.com/cgi-bin/XYV/template/LISEXT/1FRAME/index.htm	FILE E 118976
Nominal voltage UN	24 V		
Nominal current IN	3 A		

Sensor/actuator box header - SACB-6/12-L-C GG SCO - 1516755

Approvals

EAC		RU C- DE.AI30.B.01102
-----	--	--------------------------

EAC		RU C- DE.BL08.B.00511
-----	--	--------------------------

cULus Recognized		
------------------	--	--

Accessories

Accessories

Device marking

Snap-in markers - UC-EM (17,5X9) - 0827490



Snap-in markers, Sheet, white, unlabeled, can be labeled with: BLUEMARK ID, BLUEMARK ID COLOR, BLUEMARK CLED, BLUEMARK LED, CMS-P1-PLOTTER, PLOTMARK, mounting type: snapped into marker carrier, lettering field size: 17.5 x 9 mm, Number of individual labels: 20

Snap-in markers - UCT-EM (17,5X9) - 0801491



Snap-in markers, Sheet, white, unlabeled, can be labeled with: TOPMARK NEO, TOPMARK LASER, BLUEMARK ID COLOR, BLUEMARK ID, BLUEMARK CLED, THERMOMARK PRIME, THERMOMARK CARD 2.0, THERMOMARK CARD, mounting type: snapped into marker carrier, lettering field size: 17.5 x 9 mm, Number of individual labels: 24

Snap-in markers - UC-EM (17,5X9) YE - 0827494



Snap-in markers, Sheet, yellow, unlabeled, can be labeled with: BLUEMARK ID COLOR, BLUEMARK ID, BLUEMARK CLED, PLOTMARK, CMS-P1-PLOTTER, mounting type: snapped into marker carrier, lettering field size: 17.5 x 9 mm, Number of individual labels: 20

Sensor/actuator box header - SACB-6/12-L-C GG SCO - 1516755

Accessories

Snap-in markers - UCT-EM (17,5X9) YE - 0801492



Snap-in markers, Sheet, yellow, unlabeled, can be labeled with: TOPMARK NEO, TOPMARK LASER, BLUEMARK ID COLOR, BLUEMARK ID, BLUEMARK CLED, THERMOMARK PRIME, THERMOMARK CARD 2.0, THERMOMARK CARD, mounting type: snapped into marker carrier, lettering field size: 17.5 x 9 mm, Number of individual labels: 24

Labeled device marker

Snap-in markers - UC-EM (17,5X9) CUS - 0828238



Snap-in markers, can be ordered: by sheet, white, labeled according to customer specifications, mounting type: snapped into marker carrier, lettering field size: 17.5 x 9 mm, Number of individual labels: 20

Snap-in markers - UCT-EM (17,5X9) CUS - 0801575



UniCard sheet, for labeling devices from other manufacturers, for overview table see download area, labeled according to customer specifications

Snap-in markers - UC-EM (17,5X9) YE CUS - 0828239



Snap-in markers, can be ordered: by sheet, yellow, labeled according to customer specifications, mounting type: snapped into marker carrier, lettering field size: 17.5 x 9 mm, Number of individual labels: 20

Snap-in markers - UCT-EM (17,5X9) YE CUS - 0801576

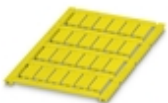

UniCard sheet, for labeling devices from other manufacturers, for overview table see download area, labeled according to customer specifications

Sensor/actuator box header - SACB-6/12-L-C GG SCO - 1516755

Accessories

Mounting rail adapter

DIN rail adapter - UTA 107 - 2853983

Universal DIN rail adapter, for screwing on switchgear



Plug for cable screw gland

Screw plug - PROT-MS SCO - 1553129



M12 screw plug with fast-locking system for unoccupied M12 female connectors of sensor/actuator cables, boxes, and flush-type connectors

Screwdriver tools

Adapter insert - TSD-M SAC-BIT ADAPTER - 1212600



Adapter bit for TSD-M...torque tools, E6.3-1/4" drive with 4 mm hexagon to accommodate SAC bits

Tool - SAC BIT M12-D15 - 1208432



Nut for assembling sensor/actuator cables with M12 connector and M12 connectors for assembly, with a knurl diameter of 15 mm, for 4 mm hexagonal drive

Sensor/actuator box header - SACB-6/12-L-C GG SCO - 1516755

Accessories

Tool - SACC BIT M12-D20 - 1208445



Nut for assembling M12 connectors for assembly with a knurl diameter of 20 mm, for 4 mm hexagonal drive

Philips screwdriver - SZK PZ1 VDE - 1206450



Screwdriver, PZ crosshead, VDE insulated, size: PZ 1 x 80 mm, 2-component grip, with non-slip grip

Tool - SAC BIT HOOD-W 24 - 1212486



Nut for assembling pressure nuts with 24 mm wrench size, for 4 mm hexagonal drive

Screw insert - SF-BIT-PZ 1-50 - 1212591



Screw bit, PZ crosshead, E6.3-1/4" drive, size: PZ 1 x 50 mm, hardened, suitable for holder according to DIN 3126-F6.3/ISO 1173

Torque tool

Torque screwdriver - TSD 04 SAC - 1208429



Torque screwdriver, with preset torque of 0.4 Nm and 4 mm hexagonal drive for M12 connectors

Sensor/actuator box header - SACB-6/12-L-C GG SCO - 1516755

Accessories

Torque screwdriver - TSD-M 1,2NM - 1212224



Torque screw driver, accuracy as per EN ISO 6789 standard, adjustable from 0.3 - 1.2 Nm

Torque screwdriver - TSD 25 SAC - 1212315



Torque screwdriver, with preset torque of 2.5 Nm and 4 mm hexagonal drive for the pressure nut of the connector hood

Torque screwdriver - TSD-M 3NM - 1212225



Torque screw driver, accuracy as per EN ISO 6789 standard, adjustable from 1.2 - 3 Nm

Necessary add-on products

Connector hood - SACB-C-H180-6/12- 5,0PUR SCO - 1516616



Connector hood, application: Sensor/actuator box, connection method: M12-SPEEDCON-socket Metal, number of slots: 6, slot assignment: Double, status display: No; master cable connection: Pluggable screw connection 180°, PUR/PVC, cable length: 5 m, shielding: no

Connector hood - SACB-C-H180-6/12-10,0PUR SCO - 1516629



Connector hood, application: Sensor/actuator box, connection method: M12-SPEEDCON-socket Metal, number of slots: 6, slot assignment: Double, status display: No; master cable connection: Pluggable screw connection 180°, PUR/PVC, cable length: 10 m, shielding: no

Sensor/actuator box header - SACB-6/12-L-C GG SCO - 1516755

Accessories

Connector hood - SACB-C-H180 6-12 SCO PUR/ - 1516687



Connector hood, application: Sensor/actuator box, connection method: M12-SPEEDCON-socket Metal, number of slots: 6, slot assignment: Double, status display: No; master cable connection: Pluggable screw connection 180°, PUR/PVC, cable length: 0.5 m ... 50 m, shielding: no

Connector hood - SACB-C-H180 8/16 SCO - 1516713



Connector hood with integrated connector with screw connection, for sensor/actuator boxes with M12 metal thread or QUICKON connection and master cable connection, for 4, 6, or 8 slots